



start

Programm 2016

Program 2016



start

Entdecken Sie mit Roco „start“ die faszinierende Welt der Modelleisenbahn



Herzlich Willkommen bei Roco! Erforschen Sie mit uns eines der kreativsten und spannendsten Hobbys. Mit dem neuen „start“ Sortiment bieten wir für Anfänger und preisbewusste Modellbahner komplett spielfertige Starter Sets und Einsteigermodelle, mit denen Sie einfach und schnell beginnen und Schritt für Schritt Ihre Anlage ausbauen können. Mit dem genormten 2-Leiter-Gleichstromsystem kennen Sie keine Grenzen und fahren international.

Baugröße H0:

H0 ist die am weitesten verbreitete Größe im Maßstab 1:87 mit einem umfangreichen Angebot an Modellen und Zubehör.



Das Roco geoLINE Gleissystem:

Damit alles richtig läuft, steht Ihnen ein perfekt zugeschnittenes Gleissystem mit einem einfachen und klaren Systemraster zur Verfügung. Eine Vielfalt von geraden und gebogenen Gleisen, Weichen und Bogenweichen, Kreuzungen, Dreiwegweichen oder flexiblen Gleisen lassen beim Ausbau Ihrer Anlage keine Wünsche offen. Eine Erweiterung Ihrer Modellanlage ermöglicht zudem die praktischen Gleissets.



Das Roco geoLINE-Gleis mit vorbildgerechter Schotterbettung. Es ist leicht zusammensteckbar, hält fest zusammen und ist auch noch trittfest.

start

Enter the fascinating world of model trains with Roco „start“



Welcome to Roco! Together, we will explore one of the most creative and exciting hobbies in the world. With our new „start“ range we offer complete starter sets and easy to use models for beginners and for model railway enthusiasts looking for great value. These sets and models allow you to start in an easy way giving you the chance to expand your system step by step. With the standard DC system you will have an international system, compatible all over the world.

Scale H0:

H0 is the most common scale in size 1:87 with a wide range of models and accessories.



The Roco geoLINE track system:

For a smooth ride a perfectly tailored track system in a simple and clear track geometry is available. A variety of straight and curved tracks, straight and curved turnouts, crossings, three-way turnouts or flexible tracks leave nothing to be desired. A systematic expansion of your layout furthermore is possible with our handy track sets.

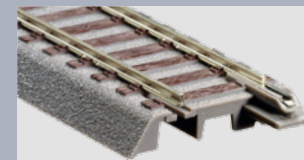

The Roco geoLINE track with realistic ballast bed. It simply clips into place and locks together tightly. You can even step on it.

Roco Kameraloks - Jetzt sind Sie mittendrin!

100 % Lokführerfeeling

Erleben Sie Ihre Anlage aus der Lokführerperspektive mit einer Kameralok: Mit dem Z21 System steuern Sie Ihre Modellbahn einfach mit Ihrem Smartphone oder Tablet über Original-Führerstände.

Roco camera locomotives - now you can be right in the thick of it!

Incredibly realistic: the ultimate train driving experience

Experience your layout from the train driver's perspective: with the Z21 system you control your model trains simply via your smartphone or tablet from original driver's cab apps.



Steuern wie ein Lokführer

Unsere Modelle sind feine Hightech-Miniaturen. Durch die neueste Technik unter der „Haube“ ist Ihr Modellzug im Nu fahrbereit und mit Z21 sogar über Ihr Smartphone oder Tablet steuerbar.

Steuerungssysteme der Modellbahn:

Analog: Steuerung über einen elektronischen Fahrregler mit Steckernetzteil. Je weiter Sie den Fahrregler aufdrehen, desto schneller fährt die Lok. Ob beschleunigen oder bremsen, alle Loks auf der Anlage verhalten sich gleich. Keine Sonderfunktionen und individuellen Geschwindigkeiten möglich.

Digital: Individuelle und gleichzeitige Steuerung mehrerer Loks, sowie Steuerung von Weichen und Signalen auf Ihrer Anlage.

Z. B. können Sie mit einer Lok rangieren, während Sie gleichzeitig einen Zug aus dem Bahnhof fahren lassen. Außerdem können Sie bei den Fahrzeugen individuelle Funktionen bedienen z. B. Originalsound, Licht ein-/ausschalten, Einstellung der Minimal-/Maximalgeschwindigkeit oder Anpassen des Bremsverhaltens.

Zum digitalen Fahren stehen Ihnen zwei Steuerungen zur Verfügung: ■ **multiMAUS** und ■ **Z21 System**

Control like a locomotive driver

Our trains are highly detailed high-tech minatures. Due to the latest technology your train will be on track in a blink – with z21 even controllable via your smartphone or tablet.

Model railway control systems:

Analogue: Via an electronic controller and power plug. The more you turn on the controller, the faster the locomotive runs. No matter if you want the loco to accelerate or brake, all locos on the layout act in the same way. No special functions and individual speed steps.

Digital: Individual control of several locos at once and independent of each other as well as switch signals and points.

This means, you are able to shunt a goods locomotive at the siding, while at the same time a passenger train is leaving the station. Besides this, you can control individual functions like original sound, switching lights on/off, control minimum/maximum speed or breaking inertia.

For your digital ride you can decide between two control systems: ■ **multiMAUS** and ■ **z21 system**

z21start

z21start ist eine einfache und kostengünstige Variante für den schnellen Fahrspaß 

Features

- **Digitales Steuern** von Lokomotiven, sowie einfaches **Lesen und Programmieren digitaler Funktionen** via WLAN multiMaus
- **Anschließen mehrerer multiMäuse** möglich (ermöglicht gleichzeitiges Steuern mehrerer Lokomotiven)
- **RailCom*-Fähigkeit**
- für WLAN vorbereitet

z21start & Z21 WLAN Package (Art. Nr. 10814)

Erweiterung der z21start durch Access Point und Freischaltcode auf eine netzwerkfähige Zentrale. Sie **steuern** sowohl Züge wie Weichen einfach **mit Ihrem Smartphone** oder **Tablet** über die bekannte Z21 App.

Features

- Selbsterklärende Steuerfunktionen Ihrer Anlage (durch Icons, Bildeinbindung, etc.)
- Automatisieren kleiner Fahrstraßen
- Steuern Sie Ihre Lokomotiven mit fotorealistischen Führerständen für das ultimative Fahrerlebnis – fühlen Sie sich wie ein echter Lokführer
- Setzt den Grundstein für PC geführte Automationen (z.B. mit Rocrail®, iTrain®, TrainController®, etc.)

* RailCom ist eine eingetragene Marke von Lenz Elektronik GmbH



z21 – Steuern aus Lokführerperspektive über fotorealistische Führerstände
z21 – Control from the view of the loco driver with photorealistic driver's cabs

Z21 
www.z21.eu

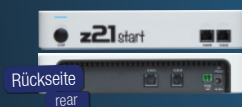

z21start

z21start ist an easy, affordable and fast variant for a lot of driving fun 

Features

- **Digital control** of locomotives, as well as easy **reading and programming of digital functions** via WiFi multiMaus
- **Various multiMaus can be connected** (so simultaneous control of several locomotives is possible)
- **RailCom* compatible**
- Equipped ready to install Wifi

z21start & Z21 WiFi Package (Item No. 10814)

The z21 Base can be extended to a network-enabled control center by using Access Point and an activation code. You can easily control both trains as well as turnouts with your **Smartphone** or **tablet** via the popular Z21 App.

Features

- Self-explanatory control functions for your model railway layout (through icons, image integration, etc.)
- You can automate routes
- Control your locomotives with photorealistic driver's cabs for the ultimate driving experience – Feel like a real real locomotive driver
- It lays the basis for PC guided automation (eg mit Rocrail®, iTrain®, TrainController®, etc.)

* RailCom is a registered trademark of Lenz Elektronik GmbH

z21 – alle Lokomotiven im Griff
z21 – each loco under control



Epochenerklärung / Epoch explanation

Ep

I

Epoche I / Epoch I: ca. 1870 – 1920

Epoche I: Mit Inbetriebnahme der ersten Deutschen Eisenbahn, dem „Adler“, begann im Jahre 1835 die Epoche I der Eisenbahngeschichte. Dabei lackierten die verschiedenen Bahngesellschaften der einzelnen Länder ihre Fahrzeuge in unterschiedlichen Farben, was für bunte Züge auf den ersten Bahnstrecken sorgte.

Epoch 1: At the time of beginning operation of the first German railway, the „Eagle“ in 1835, the Epoch I of the railway history began. The various railway companies of the different countries painted their vehicles in different colours, which led to a colourful appearance of the trains on the first railway lines.

Ep

IV

Epoche IV / Epoch IV: ca. 1965 bis 1990

Epoche IV: Ab ca. 1970 wurde in Europa ein neues Nummernsystem eingeführt, das alle Schienenfahrzeuge einheitlich kennzeichnen sollte. Dieses Nummernsystem kommt bis heute als „UIC-Nummernsystem“ zum Einsatz. Vor allem in Mitteleuropa prägten die TEE- sowie die InterCity-Züge das Bild der Bahnhöfe sowie Bahnstrecken. Gleichzeitig wurden auch die letzten verbliebenen Dampflokomotiven außer Betrieb gesetzt.

Epoch IV: Since about 1970, a new numbering system was introduced in Europe, which was supposed to designate all rail vehicles and standardize them. This „UIC numbering system“ is still in use until today. Especially in Central Europe the TEE and the intercity trains shaped the image of all stations and railway lines. At the same time the last remaining steam locomotives were decommissioned.

Ep

II

Epoche II / Epoch II: ca. 1920 – 1945/1950

Epoche II: Vom Jahre 1920 bis ca. 1945/1950 dauerte die Epoche II bei der Eisenbahn. In Deutschland wird diese Epoche auch als „Reichsbahnzeit“ bezeichnet. Dabei erhielten die meisten Lokomotiven und Wagen eine einheitliche Lackierung. Gleichzeitig war dies die Blütezeit der großen, schweren Dampflokomotiven.

Epoch II: The Railway Epoch II lasted from 1920 until about 1945/1950. In Germany, this period is also known as the „Reichsbahnzeit“. The majority of locomotives and cars were given a standard livery. This was also the heyday of the big, heavy steam locomotives.

Ep

V

Epoche V / Epoch V: 01.1994 bis 2006

Epoche V: Ab ca. 1990 mit der Privatisierung vieler Bahngesellschaften und der Gründung neuer Privatbahnen wurde das Bild der Eisenbahn immer bunter. Diese Epoche dauerte bis in das Jahr 2005/06 an.

Epoch V: Starting about 1990, with the privatization of many railway companies and the establishment of new private railways the image of the railroad was becoming even more colourful. This epoch lasted until the year 2005/06.

Ep

III

Epoche III / Epoch III: ca. 1945 – 1970

Epoche III: Bis in das Jahr 1970 waren in dieser Epoche viele vermischte Zuggarnituren unterwegs. Der Einsatz von alten Dampflokomotiven neben modernen Elektro- und Diesellokomotiven gehörte zum Alltag.

Epoch III: Until 1970 many mixed train sets were on the tracks of the railway lines during this period. The use of old steam locomotives in addition to modern electric and diesel locomotives were a part of the everyday life at that time.

Ep

VI

Epoche VI / Epoch VI: 2007 –

Epoche VI: In der heutigen Epoche haben die privaten Eisenbahnverkehrsunternehmen einen großen Anteil am internationalen Bahnbetrieb. Im Personennahverkehr und im Güterverkehr kommen viele Lokomotiven und Waggons privater Bahngesellschaften zum Einsatz. Das UIC-Nummernschema wurde international aufgrund der vielen Schienenfahrzeuge unterschiedlicher Betreiber auf eine 12-stellige Kennzeichnung erweitert.

Epoch VI: In the today's epoch, the private railway companies play an essential role in the international railway traffic. In the passenger and freight transport many locomotives and wagons of private railway companies are used. The UIC numbering scheme was extended to a 12-digit identification internationally because of the many rail vehicles of different operators.

Digital Start-Set ICE 2 mit Video Kamera, DB AG

Digital Starter Set: ICE 2 with video cam, DB AG



Ep V-VI

Inhalt:

- 1 3-teiliger ICE 2, DB AG
- 1 eingebaute Digi-Cam inkl. Sende-/Empfangsmodul
- 1 Steckernetzteil

Roco geoLine-Gleisoval:

12 Bogen R3, 8 Gerade G200



zusätzlich Smartphone od. Tablet notwendig!

Art. Nr.: 51248

€ 249,00

Contents:

- 1 three-part ICE 2, DB AG
- 1 built-in digi-cam incl. send/receiving unit
- 1 plug-in power supply

Roco geoLine track oval:

12 R3 curves, 8 G200 straights track elements



Additional smart phone or tablet necessary



Highlight

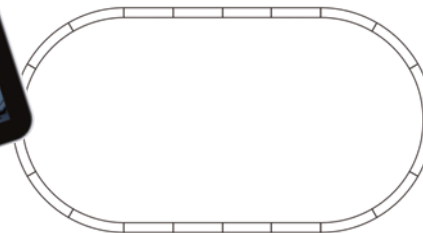

Kameralok
camera loco

Digital Starter Set: Diesellokomotive Rh 2045 mit Güterzug, ÖBB Digital Starter Set: Diesel locomotive class 2045 and freight train, ÖBB



Inhalt:

- 1 Diesellokomotive Rh 2045, ÖBB
- 1 Schiebewandwagen, 1 Offener Güterwagen
- 1 Schwenkungenwagen
- 1 x-Bus-Verstärker, 1 Steckernetzteil,
- 1 Handregler multiMaus



Roco geoLine-Gleisoval: 12 Bogen R3, 12 Gerade G200

Contents:

- 1 diesel locomotive class 2045, ÖBB
- 1 sliding wall wagon, 1 gondola
- 1 swing stake wagon
- 1 X-Bus amplifier, 1 plug-in power supply,
- 1 multiMaus



Art. Nr.: 51270

€ 219,00

Digital Starter Set: Diesellokomotive Rh 2016 mit Güterzug, ÖBB Digital Starter Set: Diesel locomotive class 2016 and freight train, ÖBB



Inhalt:

- 1 Diesellokomotive Rh 2016, ÖBB
- 1 Offener Güterwagen
- 1 Schiebeplanenwagen, 1 Teleskophaubenwagen
- 1 z21start*, 1 Steckernetzteil
- 1 Handregler multiMaus



Roco geoLine-Gleisoval: 12 Bogen R3, 12 Gerade G200

Contents:

- 1 diesel locomotive class 2016, ÖBB
- 1 gondola
- 1 sliding tarpoline car, 1 telescopic hood car
- 1 z21start*, 1 multiMaus,
- 1 plug-in power supply



Neuheit
New Set

Art. Nr.: 51282

€ 249,00

*mit WLAN Package auf eine netzwerkfähige Zentrale erweiterbar / *can be extended to a network-enabled central control unit with a Wifi package

NEU: z21start
NEW: z21start

Für WLAN vorbereitet
Equipped ready to install WiFi

RailCom*-Fähigkeit
RailCom* compatible

z21start

Nur in Starter Sets erhältlich
Available in Starter Sets only

LESEN und Programmieren erstmals mit der
multiMaus möglich. / READING and programming
now possible with multiMaus.



Rückseite
rear

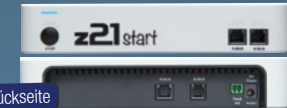

Einfache und kostengünstige
Variante zum schnellen Fahrspaß

Simple, affordable and fast variant
for a lot of driving fun

+

WLAN Erweiterung
Wifi Upgrade

**z21 WLAN Package
z21 Wifi Package**

OPTIONAL

Art. Nr.: 10814

n. E.

Steuern der Züge und Weichen mit Ihrem Smart-
phone oder Tablet über die bekannte Z21-App**
Control your trains and turnouts with your SmartPhone or
tablet via the popular Z21 App**



Selbsterklärende Steuerfunktionen Ihrer Anlage (durch
Icons, Bildeinbindung, etc.) / Self-explanatory control functions
for your model railway layout (through icons, image integration, etc.)

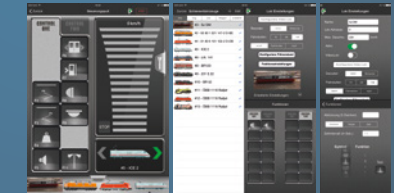

Steuern von Lokomotiven mit fotorealistischen
Führerständen für das ultimative Fahrerlebnis.
Control your locomotives with photorealistic driver's cabs for
the ultimate driving experience.



Automatisieren kleiner
Fahrstraßen / You can
automate routes

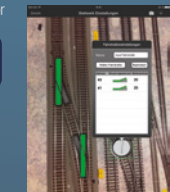

Setzt den Grundstein für PC
geführte Automationen, dank
WLAN Schnittstelle (z.B. mit
Rocrail®, iTrain®, TrainController®,
etc.) / It lays the basis for PC guided
automation, because of WiFi interface
(eg. mit Rocrail®, iTrain®, TrainCon-
troller®, etc.)



*RailCom ist eine eingetragene Marke von Lenz Elektronik GmbH / *RailCom is a registered trademark of Lenz Elektronik GmbH
**Smartphone oder Tablet sind nicht im Package enthalten / **Smartphone or tablet is not included in the package.

Digital Starter Set: Elektrolokomotive Ee3/3 mit Güterzug, SBB
 Digital Starter Set: Electric locomotive Ee3/3 and freight train, SBB



Ep V

Inhalt:

- 1 Elektrolokomotive Ee3/3, SBB
- 1 Offener Güterwagen, 1 Kesselwagen
- 1 Gedeckter Güterwagen, 1 Rungenwagen
- 1 x-Bus-Verstärker, 1 Steckernetzteil, 1 Handregler multiMaus

Roco geoLine-Gleisoval:

- 12 Bogen R3, 17 Gerade G200, 1 Weiche links (mit elektr. Antrieb + Decoder),
- 1 Prellbock, 1 Böschungsendstück

Contents:

- 1 electric locomotive Ee3/3, SBB
- 1 gondola, 1 tank wagon
- 1 boxcar, 1 stake wagon
- 1 X-Bus amplifier, 1 plug-in power supply, 1 multiMaus

Art. Nr.: 41405

€ 349,00

Roco geoLine track oval:

- 12 curves R3, 17 straight tracks G200, 1 left turnout (turnout motor + decoder),
- 1 buffer stop, 1 track end piece



mit Digital-Kupplung
with digital coupling

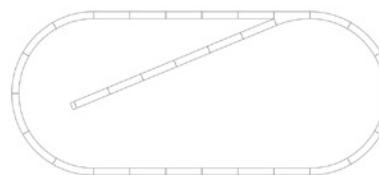

Digital Starter Set: Diesellokomotive BR 132 mit Güterzug, DR
 Digital Starter Set: Diesel locomotive class 132 and freight train, DR



Ep IV

Inhalt:

- 1 Diesellokomotive BR 132, DR
- 3 Kesselwagen „MINOL“
- 1 x-Bus-Verstärker, 1 Steckernetzteil,
- 1 Handregler multiMaus

Roco geoLine-Gleisoval:

- 12 Bogen R3, 12 Gerade G200

Art. Nr.: 51271

€ 229,00

Contents:

- 1 diesel locomotive class 132, DR
- 3 tank cars „MINOL“
- 1 X-Bus amplifier, 1 plug-in power supply,
- 1 multiMaus

Roco geoLine track oval:

- 12 curved tracks R3, 12 straight tracks G200



Digital Starter Set: Diesellokomotive BR 212 mit Kohlezug, DB
 Digital Starter Set: Diesel locomotive class 212 and coal train, DB



Ep IV

Inhalt:

- 1 Diesellokomotive BR 212, DB
- 3 Erzwagen beladen mit Kohleinsatz
- 1 z21start*, 1 Steckernetzteil
- 1 Handregler multiMaus

**Neuheit
New Set**

Roco geoLine-Gleisoval:
 12 Bogen R3, 12 Geraden G200

Art. Nr.: 51268 € 199,00

Contents:

- 1 Diesel locomotive class 212 of the DB
- 3 ore wagons that carry coal
- 1 z21start*, 1 plug-in power supply
- 1 multiMaus

**NEU: z21start
NEW: z21start**

Roco geoLine track oval:
 12 curves R3, 12 straight tracks G200



Digital Starter Set: Diesellokomotive BR 112 mit Personenzug, DR
 Digital Starter Set: Diesel locomotive class 112 and passenger train, DR



Ep IV

Inhalt:

- 1 Diesellokomotive BR 112 der DR
- 2 Personenwagen
- 1 z21start*, 1 Steckernetzteil
- 1 Handregler multiMaus

**Neuheit
New Set**

Roco geoLine-Gleisoval:
 12 Bogen R3, 12 Gerade G200

Art. Nr.: 51284 € 219,00

Contents:

- 1 diesel locomotive class 112, DR
- 2 passenger cars
- 1 z21start*, 1 plug-in power supply,
- 1 multiMaus

Roco geoLine track oval:
 12 curved tracks R3, 12 straight tracks G200



**NEU: z21start
NEW: z21start**



*mit WLAN Package auf eine netzwerkfähige Zentrale erweiterbar / *can be extended to a network-enabled central control unit with a Wifi package

Analog-Starterset: Elektrotriebzug ICE 2, DB AG

Analogue Starter Set: Electric Multiple Unit ICE2, DB AG



Ep V

Inhalt:

- 1 Elektrotriebzug ICE 2, DB AG
- 1 elektronischer Handregler
- 1 Steckernetzteil

Roco geoLine-Gleisoval:

12 Bogen R3, 6 Gerade G200

Contents:

- 1 multiple unit ICE 2, DB AG
- 1 electronic remote control
- 1 plug-in power supply

Roco geoLine track oval:

12 curved tracks R3, 6 straight tracks G200

Art. Nr.: 51153

€ 129,00

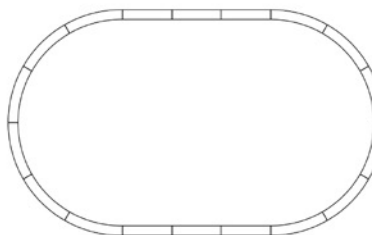

Analog-Starterset: Diesellokomotive BR 290 mit Güterzug, DB AG / Analogue Starter Set: Diesel locomotive class 290 and freight train, DB AG



Ep V

Inhalt:

- 1 Diesellokomotive BR 290, DB AG
- 1 Offener Güterwagen
- 1 Niederbordwagen
- 1 elektronischer Handregler, 1 Steckernetzteil

Roco geoLine-Gleisoval:

12 Bogen R3, 2 Gerade G200

Contents:

- 1 Diesel locomotive class 290, DB AG
- 1 gondola
- 1 low sided car
- 1 electronic remote control, 1 plug-in power supply

Roco geoLine track oval:

12 curved tracks R3, 2 straight tracks G200

Art. Nr.: 51154

€ 99,00

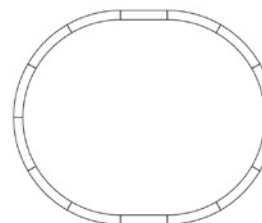

Digital Starter Set: Diesellokomotive BR 203 mit Personenzug, DB AG
 Digital Starter Set: Diesel locomotive class 203 and passenger train, DR



Ep V

Inhalt:

- 1 Diesellokomotive BR 203, DB AG
- 2 Reisezugwagen
- 1 z21start*, 1 Steckernetzteil
- 1 Handregler multiMaus

Roco geoLine-Gleisoval:

12 Bogen R3, 12 Gerade G200

Contents:

- 1 diesel locomotive class 203, DB AG
- 2 passenger cars
- 1 z21start*, 1 plug-in power supply,
- 1 multiMaus

Roco geoLine track oval:

12 curved tracks R3, 12 straight tracks G200

Neuheit
New Set



Art. Nr.: 51285

€ 219,00

NEU: z21start
NEW: z21start

Digital Starter Set: Elektrolokomotive BR 140 mit Güterzug, DB AG
 Digital Starter Set: Electric locomotive class 140 and freight train, DB AG



Ep V

Inhalt:

- 1 Elektrolokomotive BR 140, DB AG
- 2 Teleskophaubenwagen, 1 Schiebeplanenwagen
- 1 z21start*, 1 Steckernetzteil
- 1 Handregler multiMaus

Roco geoLine-Gleisoval:

12 Bogen R3, 12 Gerade G200

Contents:

- 1 electric locomotive class 140, DB AG
- 2 telescopic hood cars, 1 sliding tarpoline car
- 1 z21start*, 1 plug-in power supply unit
- 1 multiMaus

Roco geoLine track oval:

12 curved tracks R3, 12 straight tracks G200

Neuheit
New Set



Art. Nr.: 51281

€ 229,00

NEU: z21start
NEW: z21start

*mit WLAN Package auf eine netzwerkfähige Zentrale erweiterbar / *can be extended to a network-enabled central control unit with a Wifi package

Digital Starter Set ICE 2 und Diesellokomotive BR 218 mit Güterzug, DB AG

Digital Starter Set: ICE 2 and diesel locomotive class 218 with freight cars, DB AG



Ep V-VI

Inhalt:

- 1 3-teiliger ICE 2, DB AG
- 1 Diesellokomotive BR 218, DB AG
- 1 Schiebeflanwagen, 1 Teleskophaubenwagen
- 1 Niederbordwagen
- 1 z21start*, 1 Steckernetzteil, 1 Handregler multiMaus

Roco geoLine-Gleisoval:

12 Bogen R3, 14 Gerade G200, 1 Weiche links, 1 Weiche rechts, 2 Gegenbogen, 4 Ausgleichsgerade

Content:

- 1 multiple unit ICE2, DB AG
- 1 diesel locomotive series class 218, DB AG
- 1 sliding tarpoline car, 1 telescopic covered car, 1 gondola car
- 1 z21start*, 1 plug-in power supply, 1 multiMaus

Roco geoLine track oval:

12 R3 curves, 14 G200 straight track elements, 1 left switch, 1 right switch, 2 dry arches, 4 clearing tracks



Neuheit
New Set

NEU: z21start
NEW: z21start

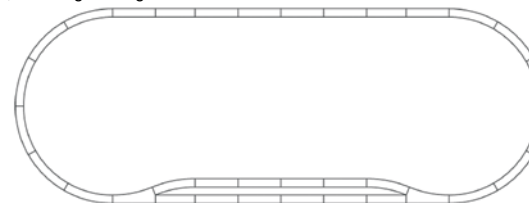

Art. Nr.: 51286

€ 329,00

Digital Starter Set: Diesellokomotive BR 253 mit Güterzug, PRESS / DB AG

Digital Starter Set: Diesel locomotive class 253 and freight train, PRESS / DB AG



PRIVAT

Ep VI

Inhalt:

- 1 Diesellokomotive BR 253, PressnitzalBahn GmbH
- 1 Offener Güterwagen, 1 Teleskophaubenwagen,
- 1 Schiebeflanwagen,
- 1 z21start*, 1 Steckernetzteil, 1 Handregler multiMaus

Roco geoLine-Gleisoval:

12 Bogen R3, 12 Gerade G200

Neuheit
New Set



NEU: z21start
NEW: z21start

Art. Nr.: 51283

€ 249,00

Contents:

- 1 diesel locomotive class 253, PressnitzalBahn GmbH
- 1 gondola, 1 telescopic hood wagon,
- 1 sliding tarpoline car
- 1 z21start*, 1 plug-in power supply, 1 multiMaus

Roco geoLine track oval:

12 curved tracks R3, 12 straight tracks G200



Digital Starter Set: Diesellokomotive BB63000 mit Güterzug, SNCF
Digital Starter Set: Diesel locomotive BB63000 and freight train, SNCF



Ep V

Inhalt:

- 1 Diesellokomotive BB63000, SNCF
- 1 Schiebeplanenwagen, 1 Teleskophaubenwagen, 1 Rungenwagen
- 1 z21start*, 1 Steckernetzteil
- 1 Handregler multiMaus

Roco geoLine-Gleisoval:
 12 Bogen R3, 12 Gerade G200

Neuheit
New Set

Contents:

- 1 diesel locomotive BB63000, SNCF,
- 1 sliding tarpoline car, 1 telescopic hood wagon,
- 1 swing stake wagon
- 1 z21start*, 1 plug-in power supply, 1 multiMaus

NEU: z21start
NEW: z21start

Roco geoLine track oval:
 12 curved tracks R3, 12 straight tracks G200



Art. Nr.: 51267

€ 229,00

Analog Starterset: Diesellokomotive D.214 mit Kranzug, FS
Analogue Starter Set: Diesel locomotive D.214 and crane train, FS



Ep IV

Inhalt:

- 1 Diesellokomotive D.214, FS
- 1 Kranwagen, 1 Schutzwagen, 1 Gedeckter Güterwagen
- 1 Steckernetzteil, 1 elektronischer Handregler

Roco geoLine-Gleisoval:
 12 Bogen R3, 4 Gerade G200

Art. Nr.: 51157

€ 129,00

Contents:

- 1 diesel locomotive D.214, FS
- 1 crane wagon, 1 barrier wagon, 1 box car
- 1 plug-in power supply unit, 1 electronic speed controller

Roco geoLine track oval:
 12 curved tracks R3, 4 straight tracks G200



*mit WLAN Package auf eine netzwerkfähige Zentrale erweiterbar / *can be extended to a network-enabled central control unit with a Wifi package

Analog Starter Set: Diesellokomotive D.214 mit Güterzug, FS
 Analogue Starter Set: Diesel locomotive D.214 and freight train, FS



Inhalt:

- 1 Diesellokomotive D.214, FS
- 1 Spitzdachwagen, 1 Gedeckter Güterwagen, 1 Offener Güterwagen
- 1 Steckernetzteil
- 1 elektronischer Handregler

Roco geoLine-Gleisoval:
 12 Bogen R3, 4 Gerade G200

Neuheit
New Set

Ep IV-V

Contents:

Art. Nr.: 51158

€ 119,00

- 1 diesel locomotive class D.214, FS
- 1 freight car, 1 box car, 1 gondola
- 1 plug-in power supply unit
- 1 electric controller

Roco geoLine track oval:
 12 curved tracks R3, 4 straight tracks G200

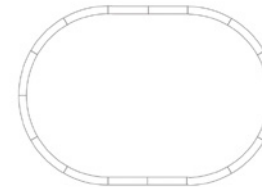

Digital-Startset: Diesellokomotive Di3 mit Personenzug, NSB
 Digital Starter Set: Diesel locomotive Di3 and passenger train, NSB



Inhalt:

- 1 Diesellokomotive Di3, NSB
- 3 Personenwagen
- 1 x-Bus-Verstärker, 1 Steckernetzteil, 1 Handregler multiMaus

Roco geoLine-Gleisoval:
 12 Bogen R3, 12 Gerade G200

Neuheit
New Set

Ep III-IV

Contents:

Art. Nr.: 51276

€ 289,00

- 1 diesel locomotive Di3, NSB
- 3 passenger carriages
- 1 x-Bus amplifier, 1 plug-in power supply, 1 multiMaus

Roco geoLine track oval:
 12 curved tracks R3, 12 straight tracks G200



H0e Analog Starter Set: Dampflokomotive mit Holzzug
 H0e Analogue Starter Set: Steam locomotive and timber train

Neuheit
New Set

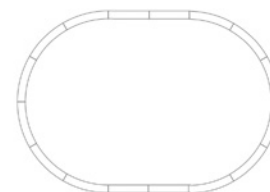

Inhalt:

- 1 Dampflokomotive
- 4 Holzlorenwagen
- 1 Steckernetzteil
- 1 elektronischer Handregler

Gleisoval:

12 Bogen, 4 Gerade

Ep II-IV

Contents:

- 1 Steam locomotive
- 4 waggons
- 1 plug-in power supply unit
- 1 electric controller

Track oval:

12 curved tracks, 4 straight tracks

Art. Nr.: 31030

€ 89,00

H0e Digital Starter Set: Dampflokomotive mit Güterzug, DR
 H0e Digital Starter Set: Steam locomotive and freight train, DR

Neuheit
New Set



NEU: z21start
NEW: z21start



DR

Inhalt:

- 1 Dampflokomotive, DR
- 2 Offene Güterwagen, 1 Gedeckter Güterwagen
- 1 z21start*, 1 Steckernetzteil
- 1 Handregler multiMaus

Gleisoval:

12 Bogen, 16 Gerade, 2 Handweichen links, 1 Handweiche rechts, 1 Ausgleichsbogen, 2 Ausgleichsgerade

Ep III

Contents:

- 1 Steam locomotive, DR
- 2 gondolas, 1 boxcar
- 1 z21start*, 1 plug-in power supply unit
- 1 multiMaus

Track oval:

12 curved tracks, 16 straight tracks, 2 left turnouts, 1 right turnout, 1 adjustment curve, 2 adjustment straights



Art. Nr.: 31031

€ 319,00

*mit WLAN Package auf eine netzwerkfähige Zentrale erweiterbar / *can be extended to a network-enabled central control unit with a Wifi package

Dampflokomotive BR 80, DB / steam locomotive class 80, DB



Ep III

111

NEM 652



Art. Nr.: 63338



€ 74,00

Dampflokomotive Baureihe 80 der Deutschen Bundesbahn.
Steam locomotive class 80 of the German Federal Railways.

Dampflokomotive BR 057, DB / Steam locomotive class 057, DB



Ep IV

217

NEM 652



Art. Nr.: 52609



€ 159,00

Dampflokomotive Baureihe 057 der Deutschen Bundesbahn.
Steam Locomotive class 057 of the German Federal Railways.

Elektrolokomotive Be 4/6, SBB / Electric locomotive Be 4/6, SBB



Neuheit
New Model

Ep II-III

187

NEM 652



Art. Nr.: 73431



€ 149,00

Art. Nr.: 79431



€ 189,00

Elektrolokomotive Be 4/6 der Schweizerischen Bundesbahnen, Ausführung mit Stirntür.
Electric locomotive Be 4/6 of the Swiss Federal Railways, version with front door.

Elektrolokomotive Be 4/6, SBB / Electric locomotive Be 4/6, SBB



Ep III-IV

187

NEM 652



Art. Nr.: 73433



€ 149,00

Art. Nr.: 79433



€ 189,00

Elektrolokomotive Be 4/6 der Schweizerischen Bundesbahnen.
Electric locomotive Be 4/6 of the Swiss Federal Railways.

Elektrolokomotive Ae 6/6, SBB / Electric locomotive Ae 6/6



Ep IV-V

212

NEM 652



Neuheit
New Model

Art. Nr.: 52660 = € 129,00

Art. Nr.: 58660 ~ € 169,00

Elektrolokomotive Ae 6/6 11406 der Schweizerischen Bundesbahnen mit Wappen Obwalden.
Electric locomotive Ae 6/6 of the Swiss Federal Railways with Obwaldne emblem.

Elektrolokomotive BR 111, DB / Electric locomotive class 111, DB



Ep IV

190

NEM 652



Art. Nr.: 72298 = € 129,00

Art. Nr.: 78298 ~ € 169,00

Elektrolokomotive Baureihe 111 der Deutschen Bundesbahn in ozeanblau-beiger Farbgebung.
Electric locomotive class 111 of the German Federal Railways in ocean blue and beige livery.

Elektrolokomotive BR 144, DB / Electric locomotive class 144, DB



Ep IV

176

NEM 652



Art. Nr.: 52540 = € 129,00

Art. Nr.: 58540 ~ € 169,00

Die Baureihe E 44 stellte einen Meilenstein der deutschen Elektrolokomotiv-Entwicklung dar und prägte den elektrischen Eisenbahnverkehr von 1932 bis in die 1980er-Jahre.

The class E 44 represented a landmark in the development of German electric locomotives and made a decisive impact on the railway traffic from 1932 until the 1980s.

Elektrolokomotive BR 244, DR / Electric locomotive class 244, DR



Ep IV

176

NEM 652



Art. Nr.: 52541 = € 129,00

Elektrolokomotive Baureihe 244 der Deutschen Reichsbahn. In der DDR wurden die BR E 44 zur BR 244 umbenannt.

The last locomotives of the class E 44 that operated in the GDR were designated class 244.

3-teiliges Zugset ICE 2, DB AG / 3-part train-set ICE 2, DB AG



Ep VI

742

NEM 652



■ Passende Ergänzungswagen unter Art. Nr. 54270 und 54271 erhältlich ■ Suitable cars: Item Nr. 54270 and 54271

Art. Nr.: 63087	=	€ 109,00
Art. Nr.: 63088	DCC	€ 139,00

Set bestehend aus einem motorisiertem Triebkopf, einem Steuerwagen und einem Bordrestaurant-Zwischenwagen im aktuellen Betriebszustand der Epoche VI mit langer UIC Nummer. Modell im Längenmaßstab 1:100 gehalten. Stirnbeleuchtung mit Fahrtrichtung wechselnd.

Set consists of one motorized traction unit, one driving trailer and one on-board restaurant- intermediate wagon in current operation condition of the Epoch VI and with long UIC number. Model in scale 1:100. Headlight changes with the direction of travel.

Straßenbahn / Tramway



PRIVAT

Ep III-V

232

NEM 652



Art. Nr.: 52582	=	€ 99,00
-----------------	---	---------

Gelenktriebwagen 6-achsig in blau/weißer Farbgebung. Unterflurantrieb auf ein Drehgestell, freie Sicht durch den Fahrgastraum mit Inneneinrichtung.

6-axle tramway in blue and white livery. Underfloor drive mechanism and therefore an unobstructed view in the passenger compartment with interior design.

Straßenbahn / Tramway



PRIVAT

Ep III-V

232

NEM 652



Art. Nr.: 52583	=	€ 99,00
-----------------	---	---------

Gelenktriebwagen 6-achsig in rot/weißer Farbgebung. Unterflurantrieb auf ein Drehgestell, freie Sicht durch den Fahrgastraum mit Inneneinrichtung.

6-axle tramway in red and white livery. Underfloor drive mechanism and therefore an unobstructed view in the passenger compartment with interior design.

Diesellokomotive Rh 2043, ÖBB / Diesel locomotive class 2043, ÖBB



Ep IV

182

PluX22

Art. Nr.: 52480	=	€ 129,00
Art. Nr.: 52481	=	€ 199,00
Art. Nr.: 58481	~	€ 199,00

Diesellokomotive Reihe 2043 der Österreichischen Bundesbahnen, **erstmalig mit LED-Spitzenlicht**.
Diesel locomotive class 2043 of the Austrian Federal Railways **now with LED-lighting**.

Diesellokomotive BR V 200, DB / Diesel locomotive class V 200, DB



Ep III

212

NEM 652

Art. Nr.: 72988	=	€ 119,00
Art. Nr.: 78988	~	€ 159,00

Diesellokomotive Baureihe V 200 der Deutschen Bundesbahn.
Diesel locomotive class V 200 of the German Federal Railways.

Diesellokomotive BR V 100, DB / Diesel locomotive class V 100, DB



Ep III

139

NEM 652

Art. Nr.: 52520	=	€ 89,00
Art. Nr.: 58520	~	€ 129,00

Die robusten Maschinen der BR V100.10 waren typische Universalloks und zogen Reise- und Güterzüge vor allem auf Nebenbahnen. / The robust machines of the class V100.10 were typical general purpose locomotives and mainly pulled passenger and freight trains on branch lines.

Schienenbus BR 798/ 998, DB / Railbus class 798/ 998, DB



Ep IV

320

NEM 652

Art. Nr.: 52630	=	€ 119,00
Art. Nr.: 52631	=	€ 194,00

Schienenbus Baureihe 798/ 998 der Deutschen Bundesbahn.
Railbus class 798/ 998 of the German Federal Railways.

Diesellokomotive BR 132, DR / Diesel locomotive class 132, DR



Ep IV

239

NEM 652



Art. Nr.: 52502 = € 99,00

Art. Nr.: 52503 = € 169,00

Die Diesellokomotiven der BR 132 wurden ab 1970 aus der damaligen Sowjetunion in die DDR importiert. / The diesel locomotives of the class 132 were imported from the former Soviet Union.

Diesellokomotive BR 232, DB AG / Diesel locomotive class 232, DB AG



Ep V

239

NEM 652



Art. Nr.: 52500 = € 99,00

Art. Nr.: 52501 = € 169,00

Art. Nr.: 58501 ~ € 169,00

Die als Baureihe 232 eingereichten Diesellokomotive der DB AG stammen aus der Lokomotivfabrik Woroschilowgrad (UA). The diesel locomotive of the DB AG is classified as class 232 and came from the locomotive factory Woroschilowgrad (UA).

Diesellokomotive BR 365, DB AG / Diesel locomotive class 365, DB AG



Ep V

120

NEM 652



Art. Nr.: 52530 = € 99,00

Art. Nr.: 58530 ~ € 139,00

Diesellokomotive Baureihe 365 der Deutschen Bahn AG.
Diesel locomotive class 365 of the Deutsche Bahn AG.



Diesellokomotive MY, DSB / Diesel locomotive MY, DSB



DSB

Ep IV

218

NEM 652



Art. Nr.: 52614	=	€ 139,00
Art. Nr.: 52615	=	€ 214,00
Art. Nr.: 58615	~	€ 214,00

Diesellokomotive Reihe MY der Dänischen Staatsbahn.
Diesel locomotive MY of the Danish State Railways.

Diesellokomotive Y8400, SNCF / Diesel locomotive Y8400, SNCF



SNCF

Ep V

115



Art. Nr.: 52515	=	€ 69,00
-----------------	---	---------

Die Kleindiesellokomotiven wurden von Arbel Fauvet gebaut und sind in ganz Frankreich im Einsatz.
The small Diesel locomotives were delivered by Arbel Fauvet throughout France in the early 1990s.

Diesellokomotive Y8400, SNCF / Diesel locomotive Y8400, SNCF



SNCF

Neuheit
New Model

Ep VI

115



Art. Nr.: 52517	=	€ 69,00
-----------------	---	---------

Diesellokomotive Y8400 der Französischen Staatsbahn.
Diesel locomotive Y8400 of the French State Railways.

Diesellokomotive M61.001, MAV / Diesel locomotive M 61.001, MAV



MUSEUMSAUSFÜHRUNG M61.001
MUSEUM-EDITION M61.001

Ep V-VI

218

NEM 652



Art. Nr.: 52618	=	€ 139,00
Art. Nr.: 52619	=	€ 214,00

Diesellokomotive M61.001 der Ungarischen Staatsbahn in Ausführung der aktuellen Museumslok.
Diesel locomotive M61.001 of the Hungarian State Railways in current museum look and design.

Diesellokomotive D.214, FS / Diesel locomotive D.214, FS



Ep V

83



Art. Nr.: 52650 = € 75,00

Diesellokomotive D.214 der Italienischen Staatsbahn.
Diesel locomotive D.214 of the Italian State Railways.

Diesellokomotive Serie 2200, NS / Diesel locomotive class 2200, NS



Ep III

161

NEM 652



Neuheit
New Model

Art. Nr.: 52510 = € 84,00

Art. Nr.: 58510 ~ € 124,00

Diesellokomotive Serie 2200 der Niederländischen Staatsbahn.
Diesel locomotive class 2200 of the Dutch State Railways.

Diesellokomotive Serie 2200, NS / Diesel locomotive class 2200, NS



Ep IV

161

NEM 652



Art. Nr.: 52511 = € 84,00

Art. Nr.: 58511 ~ € 124,00

Diesellokomotive Serie 2200 der Niederländischen Staatsbahn.
Diesel locomotive class 2200 of the Dutch State Railways.

Diesellokomotive Di5, NSB / Diesel locomotive Di5, NSB



Ep V

120

NEM 652



Art. Nr.: 52532 = € 104,00

Art. Nr.: 52533 DCC € 169,00

Art. Nr.: 58533 ~ € 169,00

- Art. Nr. 52533 und 58533: mit Digital-Kupplung
- Item Nr. 52533 and 58533: with digital coupling

Diesellokomotive Di5 der Norwegischen Staatsbahn.
Diesel locomotive Di5 of the Norwegian State Railways.

Eurofima-Schnellzugwagen 1. Klasse, ÖBB

1st class Eurofima passenger car, ÖBB



Art. Nr.: 54240 € 24,90 ■ Längenmaßstab 1:100 ■ in scale 1:100

Schnellzugwagen 1. Klasse der Österreichischen Bundesbahnen.
1st class express train wagon of the Austrian Federal Railways.

Eurofima-Schnellzugwagen 2. Klasse, ÖBB

2nd class Eurofima passenger car, ÖBB



Art. Nr.: 54241 € 24,90 ■ Längenmaßstab 1:100 ■ in scale 1:100

Schnellzugwagen 2. Klasse der Österreichischen Bundesbahnen.
2nd class express train wagon of the Austrian Federal Railways.

RIC-Speisewagen, ÖBB

RIC Dining car, ÖBB



Art. Nr.: 54242 € 24,90 ■ Längenmaßstab 1:100 ■ in scale 1:100

Speisewagen der Österreichischen Bundesbahnen.
Dining car of the Austrian Federal Railways.

Personenwagen 2. Klasse, ČSD

2nd class passenger carriage, ČSD



Art. Nr.: 54335 € 12,90

Personenwagen 2. Klasse der Tschechoslowakischen Staatsbahnen.
2nd class passenger carriage of the Czechoslovakian State Railways.

Personenwagen 2. Klasse, DR
2nd class passenger carriage, DR

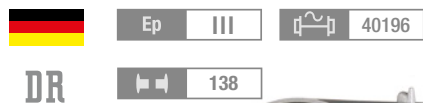

Art. Nr.: 54334 € 12,90

Personenwagen 2. Klasse der Deutschen Reichsbahn.
2nd class passenger carriage of the Deutsche Reichsbahn.

IC-Abteilwagen 1. Klasse, DB AG
1st class compartment car, DB AG

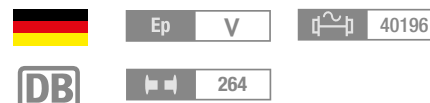

Art. Nr.: 54260 € 27,90 ■ Längenmaßstab 1:100 ■ in scale 1:100

Schnellzugwagen 1. Klasse der Deutschen Bahn AG.
1st class express train wagon of the Deutsche Bahn AG.

IC-Großraumwagen 2. Klasse, DB AG
2nd class saloon car, DB AG

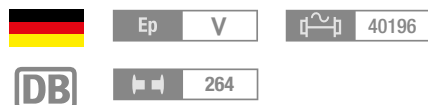

Art. Nr.: 54261 € 27,90 ■ Längenmaßstab 1:100 ■ in scale 1:100

Schnellzugwagen 2. Klasse der Deutschen Bahn AG.
2nd class express train wagon of the Deutsche Bahn AG.

IC-Steuerwagen, DB AG
IC cab car, DB AG

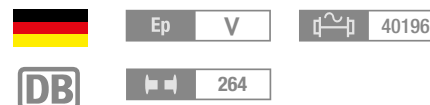

Art. Nr.: 54262 € 37,90 ■ Längenmaßstab 1:100 ■ in scale 1:100

Schnellzug-Steuerwagen 2. Klasse der Deutschen Bahn AG.
2nd class express train cab car of the Deutsche Bahn AG.

ICE-Zwischenwagen 1. Klasse, DB AG

1st class ICE intermediate car, DB AG

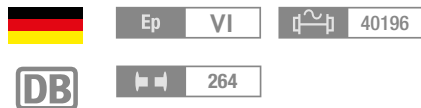

- Passend zu Art. Nr. 63087, 63088
- Suitable for Item Nr. 63087, 63088



Art. Nr.: 54270 € 27,40 ■ Längenmaßstab 1:100 ■ Längenmaßstab 1:100

ICE-Zwischenwagen 1. Klasse der Deutschen Bahn AG.
1st class ICE intermediate car of the Deutsche Bahn AG.

ICE-Zwischenwagen 2. Klasse, DB AG

2nd class ICE intermediate car, DB AG

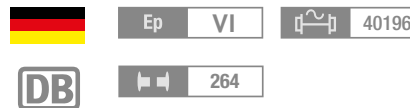

- Passend zu Art. Nr. 63087, 63088
- Suitable for Item Nr. 63087, 63088



Art. Nr.: 54271 € 27,40 ■ Längenmaßstab 1:100 ■ Längenmaßstab 1:100

ICE-Zwischenwagen 2. Klasse der Deutschen Bahn AG.
2nd class ICE intermediate car of the Deutsche Bahn AG.

Personenwagen 1. Klasse, RENFE

1st class passenger carriage, RENFE



Neuheit
New Model



Art. Nr.: 54330 € 12,90

Personenwagen 1. Klasse der Spanischen Staatsbahn.
1st class passenger carriage of the Spanish State Railways.

Personenwagen 2. Klasse, RENFE

2nd class passenger carriage, RENFE



Neuheit
New Model



Art. Nr.: 54331 € 12,90

Personenwagen 2. Klasse der Spanischen Staatsbahn.
2nd class passenger carriage of the Spanish State Railways.

Personenwagen 3. Klasse, RENFE

3rd class passenger carriage, RENFE



Neuheit
New Model



Art. Nr.: 54332 € 12,90

Personenwagen 3. Klasse der Spanischen Staatsbahn.
3rd class passenger carriage of the Spanish State Railways.

8-teiliges Set Güterwagen, ÖBB

8-piece set freight cars, ÖBB



Art. Nr.: 44006

€ 54,00

Acht unterschiedliche Güterwagen der Österreichischen Bundesbahnen.

Eight different goods wagons of the Austrian Federal Railways.

Talbot-Schotterwagen, ÖBB

Talbot hopper car, ÖBB



Art. Nr.: 56249

€ 14,90

Talbot-Schotterwagen der Österreichischen Bundesbahnen.

Talbot hopper car of the Austrian Federal Railways.

Offener Güterwagen, ÖBB

Gondola, ÖBB



Art. Nr.: 56266

€ 9,90

■ Offener Güterwagen, ÖBB

■ Gondola, ÖBB

Kranwagen mit Schutzwagen, ÖBB

Crane wagon and barrier wagon, ÖBB



Schutzwagen /
barrier wagon

Kranwagen /
crane wagon

Neuheit
New Model



Art. Nr.: 56239

€ 29,90

Kranwagen mit Schutzwagen der Österreichischen Bundesbahnen.

Crane wagon and barrier wagon of the Austrian Federal Railways.

Gedeckter Güterwagen, CSD

Boxcar, CSD



Art. Nr.: 56232

€ 16,90

Gedeckter Güterwagen der Tschechoslowakischen Staatsbahnen.
Boxcar of the Czechoslovakian State Railways.

Talbot-Schotterwagen, CSD

Talbot hopper car, CSD



Art. Nr.: 56250

€ 14,90

Talbot-Schotterwagen der Tschechoslowakischen Staatsbahnen.
Talbot hopper car of the Czechoslovakian State Railways.

Offener Güterwagen, CD

Gondola, CD



Art. Nr.: 56272

€ 9,90

Offener Güterwagen der Tschechischen Staatsbahn.
Gondola of the Czech State Railways.

Offener Güterwagen, CD Cargo

Gondola, CD Cargo



Neuheit
New Model



Art. Nr.: 56274

€ 9,90

Offener Güterwagen der Tschechischen Staatsbahn.
Gondola, of the Czech State Railways.

Kesselwagen, CD Cargo

Tank car, CD Cargo



Neuheit
New Model



Art. Nr.: 67594

€ 17,90

Kesselwagen der Tschechischen Staatsbahn.
Tank car of the Czech State Railways.

8-teiliges Set Güterwagen, DRG

8-piece set freight cars, DRG



Art. Nr.: 44003

€ 54,00

Acht unterschiedliche Güterwagen der Deutschen Reichsbahn Gesellschaft.
Eight different freight cars of the German Reichsbahn Gesellschaft.

Talbot-Schotterwagen, DRG

Talbot hopper car, DRG



Neuheit
New Model



Art. Nr.: 56248

€ 14,90

Talbot-Schotterwagen der Deutschen Reichsbahn Gesellschaft.
Talbot hopper car of the German Reichsbahn Gesellschaft.

Talbot-Schotterwagen, DB

Talbot hopper car, DB



Art. Nr.: 56245

€ 14,90

Talbot-Schotterwagen der Deutschen Bundesbahn.
Hopper car type Talbot of the German Federal Railways.

8-teiliges Set Güterwagen, DB

8-piece set freight cars, DB



Art. Nr.: 44002

€ 54,00

Acht unterschiedliche Güterwagen der Deutschen Bundesbahn.
Eight different goods wagons of the German Federal Railways.

Offener Güterwagen, DB

Gondola, DB



Art. Nr.: 46039

€ 9,90

Offener Güterwagen der Deutschen Bundesbahn mit Holzwänden.
Gondola of the German Federal Railways.

Gedeckter Güterwagen, DR

Boxcar, DR



Art. Nr.: 56234

€ 16,90

Gedeckter Güterwagen der Deutschen Reichsbahn.
Boxcar of the Deutsche Reichsbahn.

8-teiliges Set Güterwagen, DR

8-piece set freight cars, DR



DR



Art. Nr.: 67127

€ 54,00

Acht unterschiedliche Güterwagen der Deutschen Reichsbahn.
Eight different freight cars of the Deutsche Reichsbahn.

Rungenwagen, DB

Stake wagon, DB

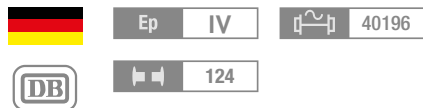

Art. Nr.: 46031 € 9,90

Rungenwagen der Deutschen Bundesbahn.
Stake wagon of the German Federal Railways.

Gedeckter Güterwagen, DB

Boxcar, DB

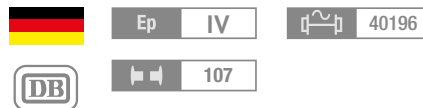

Art. Nr.: 56233 € 16,90

Gedeckter Güterwagen der Deutschen Bundesbahn.
Boxcar of the German Federal Railways.

Gedeckter Güterwagen, DB

Boxcar, DB

Neuheit
New Model



Art. Nr.: 56067 € 13,90

Gedeckter Güterwagen der Deutschen Bundesbahn.
Boxcar of the German Federal Railways.

Kühlwagen, DB

Refrigerator car, DB

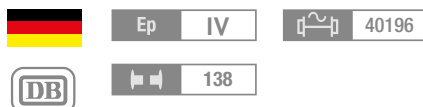

Art. Nr.: 56125 € 12,40

Kühlwagen der Deutschen Bundesbahn.
Refrigerator car of the German Federal Railways.

Offener Güterwagen, DB

Gondola, DB

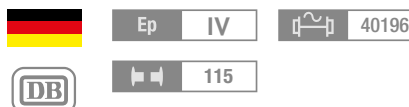

Art. Nr.: 56277 € 9,90

Offener Güterwagen der Deutschen Bundesbahn.
Gondola of the German Federal Railways.

Offener Güterwagen, DB

Gondola, DB

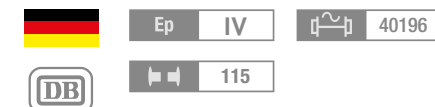

Art. Nr.: 67502 € 14,90

Offener Güterwagen der Deutschen Bundesbahn, beladen mit Feinkohle.
Gondola of the German Federal Railways, loaded with coal.

Kesselwagen ARAL, DB

ARAL tank car, DB

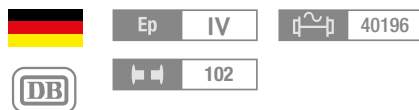

Art. Nr.: 56258

€ 17,90

Kesselwagen ARAL, eingestellt bei der Deutschen Bundesbahn.
ARAL tank car hired out to the German Federal Railways.

Niederbordwagen, DR

Gondola, DR

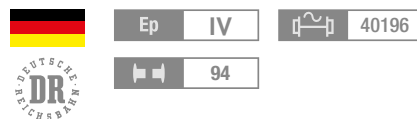

Art. Nr.: 56017

€ 9,90

Niederbordwagen der Deutschen Reichsbahn.
Gondola of the Deutsche Reichsbahn.

Gedeckter Güterwagen, DR

Boxcar, DR



Art. Nr.: 56068

€ 13,90

Güterwagen der Deutschen Reichsbahn mit schwarzem Rahmen.
Boxcar of the Deutsche Reichsbahn with black frame.

Gedeckter Güterwagen, DR

Boxcar, DR

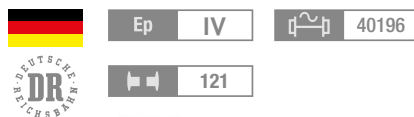

Art. Nr.: 56069

€ 13,90

Güterwagen der Deutschen Reichsbahn mit braunem Rahmen.
Boxcar of the Deutsche Reichsbahn with brown frame.

Talbot Schotterwagen, DR

Talbot hopper car, DR

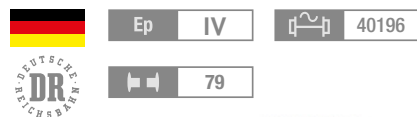

Art. Nr.: 56247

€ 14,90

Talbot-Schotterwagen der Deutschen Reichsbahn.
Talbot hopper car of the Deutsche Reichsbahn.

Offener Güterwagen, DR

Gondola, DR



Art. Nr.: 56271

€ 9,90

Offener Güterwagen der Deutschen Reichsbahn.
Gondola of the Deutsche Reichsbahn.

Kesselwagen MINOL, DR / Tank car MINOL, DR

Neuheit
New Model



Ep IV 40196



102



Art. Nr.: 56256 € 17,90

Kesselwagen MINOL, eingestellt bei der Deutschen Reichsbahn.
Tank car MINOL hired out to the Deutsche Reichsbahn.

Kesselwagen GATX / Tank car, GATX



Ep VI 40196

PRIVAT

102



Art. Nr.: 56260 € 17,90

Kesselwagen GATX.
Tank car GATX.

Kranwagen mit Schutzwagen, DB AG

Crane car with barrier car, DB AG



Ep V 40196

40195



275

Schutzwagen /
barrier wagon

Kranwagen /
crane wagon



Art. Nr.: 56240 € 29,90

6-achsiger Kranwagen mit 2-achsigem Schutzwagen der Deutschen Bahn AG.
6-axlw crane wagon and 2-axle barrier wagon of the Deutsche Bahn AG.

Talbot-Schotterwagen, DB AG

Talbot hopper car, DB AG



Ep V 40196



79



Art. Nr.: 56246 € 14,90

Talbot-Schotterwagen der Deutschen Bahn AG.
Talbot hopper car of the Deutsche Bahn AG.

Kesselwagen CAMPSA, RENFE / Tank car CAMPSA, RENFE



Neuheit
New Model



Art. Nr.: 56262 € 17,90

Kesselwagen CAMPSA, eingestellt bei der Spanischen Staatsbahn.
Tank car CAMPSA hired out to the Spanish State Railways.

Gedeckter Güterwagen, SNCF / Boxcar, SNCF



Art. Nr.: 56230 € 16,90

Gedeckter Güterwagen der Französischen Staatsbahn.
Boxcar of the French State Railways.

Offener Güterwagen , SNCF

Gondola, SNCF

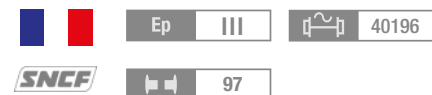

Art. Nr.: 56281 € 9,90

Offener Güterwagen der Französischen Staatsbahn.
Gondola of the French State Railways.

Offener Güterwagen, SNCF

Gondola, SNCF



Neuheit
New Model



Art. Nr.: 56283 € 9,90

Offener Güterwagen der Französischen Staatsbahn.
Gondola of the French State Railways.

Offener Güterwagen, SNCF

Gondola, SNCF

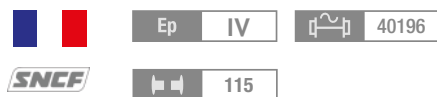

Art. Nr.: 56267 € 9,90

Offener Güterwagen der Französischen Staatsbahn.
Gondola of the French State Railways.

Kleinviehwagen, MAV

Stock car, MAV



Art. Nr.: 56190 € 14,90

Transportwagen für Kleinvieh der Ungarischen Staatsbahn.
For the transportation of small livestock of the Hungarian State Railways.

Gedeckter Güterwagen, MAV

Boxcar, MAV



Art. Nr.: 56235 € 16,90

Gedeckter Güterwagen der Ungarischen Staatsbahn.
Boxcar of the Hungarian State Railways.

Neuheit
New Model

Offener Güterwagen, MAV

Gondola, MAV

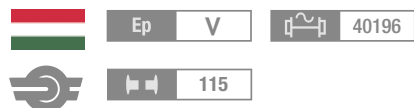

Art. Nr.: 56270 € 9,90

Offener Güterwagen der Ungarischen Staatsbahn.
Gondola of the Hungarian State Railways.

Offener Güterwagen, GySEV

Gondola, GySEV

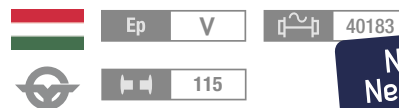

Neuheit
New Model



Art. Nr.: 56268 € 9,90

Offener Güterwagen der GySEV.
Gondola type of the GySEV.

Gedeckter Güterwagen, FS

Boxcar, FS



Art. Nr.: 47526 € 12,90

Gedeckter Güterwagen mit Spitzdach der Italienischen Staatsbahn.
Box car with pointed roof of the Italian State Railways.

Talbot-Schotterwagen, FS

Talbot hopper car, FS

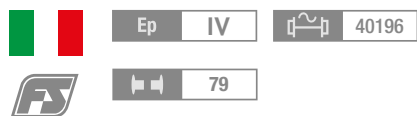

Art. Nr.: 56251

€ 14,90

Talbot-Schotterwagen der Italienischen Staatsbahn.
Talbot hopper car of the Italian State Railways.

Offener Güterwagen mit Kohle, FS

Gondola that carries coal, FS

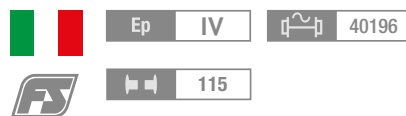

Art. Nr.: 56273

€ 14,90

Offener Güterwagen der Italienischen Staatsbahn beladen mit Kohle. / Gondola of the Italian State Railways that carries coal.

Gedeckter Güterwagen, FS

Boxcar, FS



Art. Nr.: 56301

€ 16,90

Gedeckter Güterwagen mit Plattenwänden der Italienischen Staatsbahn. / Boxcar with slab walls of the Italian State Railways.

Gedeckter Güterwagen, FS

Boxcar, FS

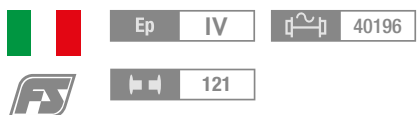

Art. Nr.: 56302

€ 16,90

Gedeckter Güterwagen mit Holzwänden der Italienischen Staatsbahn. / Boxcar with wooden walls of the Italian State Railways.

Kesselwagen VTG, FS

Tank car VTG, FS

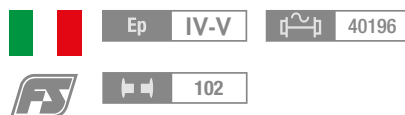

Art. Nr.: 56261

€ 17,90

Kesselwagen VTG, eingestellt bei der Italienischen Staatsbahn.
Tank car VTG hired out to the Italian State Railways.

Gedeckter Güterwagen, CFL

Boxcar, CFL



Art. Nr.: 67459

€ 16,90

Gedeckter Güterwagen der Luxemburgischen Staatsbahn.
Boxcar of the Luxembourgian State Railways.

Offener Güterwagen, NS

Gondola, NS



Art. Nr.: 56280

€ 9,90

Offener Güterwagen der Niederländischen Staatsbahn.
Gondola of the Dutch State Railways.

8-teiliges Set Güterwagen, NS

8 piece set freight cars, NS



Art. Nr.: 67128

€ 54,00

Acht unterschiedliche Güterwagen, eingestellt bei der Niederländischen Staatsbahn.
Eight different goods wagons hired out to the Dutch State Railways.

Gedeckter Güterwagen, NS

Boxcar, NS



Art. Nr.: 67461

€ 16,90

Gedeckter Güterwagen der Niederländischen Staatsbahn.
Boxcar of the Dutch State Railways.

Gedeckter Güterwagen, PKP

Boxcar, PKP



Neuheit
New Model



Art. Nr.: 56229

€ 16,90

Gedeckter Güterwagen der Polnischen Staatsbahn.
Boxcar of the Polish State Railways.

Talbot-Schotterwagen, PKP

Talbot hopper car, PKP



Art. Nr.: 56244

€ 14,90

Talbot-Schotterwagen der Polnischen Staatsbahn.
Talbot hopper car of the Polish State Railways.

Offener Güterwagen, PKP

Gondola, PKP



Art. Nr.: 56269

€ 9,90

Offener Güterwagen der Polnischen Staatsbahn.
Gondola of the Polish State Railways.

H0e: Feldbahn Diesellokomotive „Leo“

H0e: Light railway diesel locomotive „Leo“



Art. Nr.: 33209



€ 49,90

Feldbahn Diesellokomotive „Leo“. Antrieb auf drei Achsen.
Light railway Diesel locomotive „Leo“. Drive on three axes.

H0e: 2-teiliges Set Kipploren

H0e: 2 piece set side tipping wagons

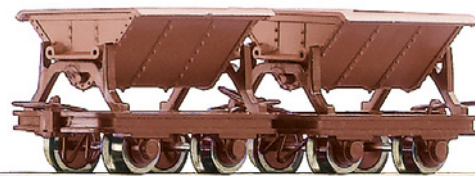

Art. Nr.: 34498

€ 13,40

H0e: 2-teiliges Set Kohlenloren

H0e: 2 piece set side tipping wagons



Art. Nr.: 34499

€ 13,40



Das Roco geoLine Gleis

Technik:

- Fahren mit dem international weit verbreiteten 2-Leiter-Gleichstromsystem
- Ideale Stromleiteigenschaften durch Vollprofilschienen aus einer hochwertigen Neusilberlegierung

Das Gleis:

- Realistisches Aussehen
- Sichere und stabile Verbindung der Gleise, einfacher Zusammenbau
- Robust und trittfest durch stabiles Schotterbett aus Kunststoff
- Schallgedämpft
- Günstiger Preis

Die Gleisgeometrie:

- Einfacher, übersichtlicher Systemraster
- Alle Weichen sind nachträglich auf elektrische Fernbedienung umrüstbar

The Roco geoLine track

Technology:

- Running with the internationally widespread 2-wire DC system
- Ideal current carrying capacity even on solid profile rails made of high quality nickel silver alloy.

The track:

- Realistic appearance
- Secure and stable connection to the tracks, easy assembly
- Robust and crush resistant plastic ballast bed
- Silenced
- Available at a convenient price

The track geometry:

- Easy and clear grid system
- All switches can be retrofitted for electrical remote control at a later date



Das geoLine Gleis: Robust und trittfest
The geoLine track: is of a robust construction and crush resistant

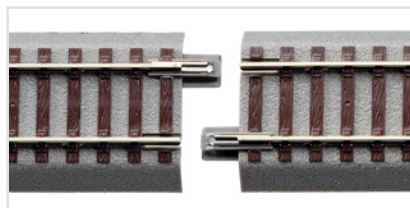

Sichere und stabile Verbindung der Gleise
Secure and stable connection to the tracks

geoLine-Gleisssets: Erweiterung eines großen Gleisovals – mit den preisgünstigen Gleisssets geoLine Track Sets: extension of a large track oval – with the best-price track sets

**Preisvorteil
Price advantage**

Weitere mögliche Kombinationen /
further options:
 Starter Set +A1 +B1 +C1
 Starter Set +B1
 Starter Set +A1 +C1
 Starter Set +B1 +C1

Starter Set* / Starter Set*

mit Gleis-Inhalt: (12 x G200 (61110), 12 x Bogen R3 (61123) z. B.:
 with track content: 12 x G200 (61110), 12 x curves R3 (61123) i.e.:

**Alle / all Starter Sets:
www.roco.cc**

- *51270
- 51282
- 51271
- 51268
- 51284
- 51285
- 51281
- 51283
- 51267
- 51276

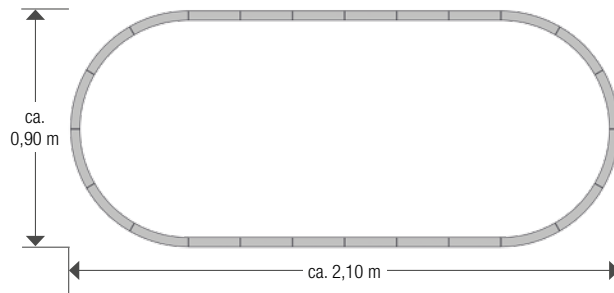

geoLine Gleisset A1 geoLine track set A1

Art. Nr.: 61150

€ 29,90

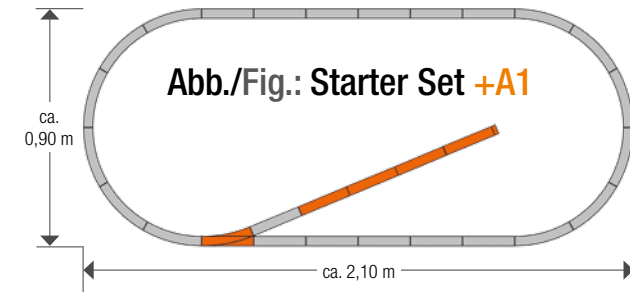

Inhalt: 4x Gerade G200, 1x Handweiche links, 1x Prellbock-Bausatz, 1 Bettungsendstück.
 Platzbedarf ca. 210 x 90 cm

Contents: 4x straight tracks G200, 1x manual turnout, left, 1x buffer stop kit, 1 roadbed end piece.
 Space required: approx. 210 x 90 cm

geoLine Gleisset B1 geoLine track set B1

Art. Nr.: 61151

€ 49,90

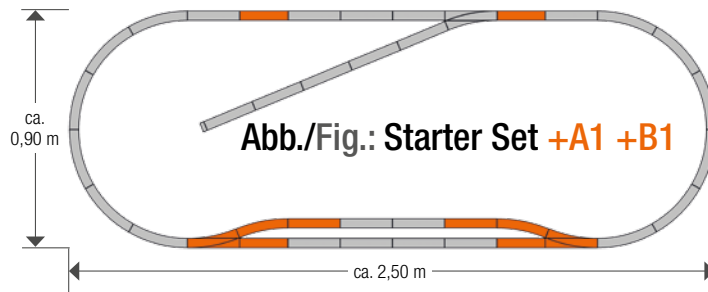

Inhalt: 2x Gerade G200, 4x Gerade G185, 2x Bogengleise GB2, 1x Handweiche links, 1x Handweiche rechts.
 Platzbedarf ca. 250 cm x 90 cm

Contents: 2x straight tracks G200, 4x straight tracks G185, 2x curved tracks GB2, 1x manual turnout left, 1x manual turnout, right. Space required: approx. 250 x 90 cm

geoLine Gleisset C1 geoLine track set C1

Art. Nr.: 61152

€ 69,90

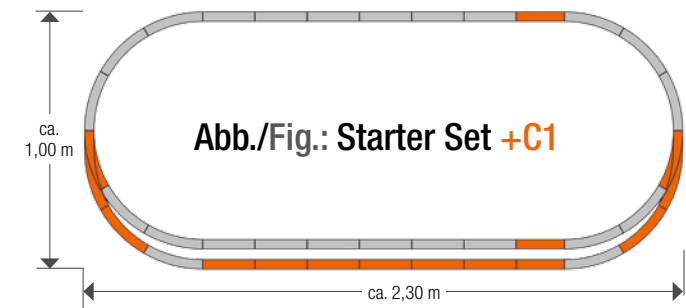

Inhalt: 6x Gerade G200, 3x Gerade G185, 2x Bogengleise R3, 1x Handbogenweiche links, 1x Handbogenweiche rechts. Platzbedarf ca. 230 x 100 cm

Contents: 6x straight tracks G200, 3x straight tracks G185, 2x curved tracks R3, 1x manual curved turnout left, 1x manual curved turnout right. Space required: approx. 230 x 100 cm

geoLine-Gleissets: Erweiterung eines Gleisovals A / geoLine Track sets: extension of a track oval A

geoLine Gleisset B Track set B

Art. Nr.: 61101

€ 49,90

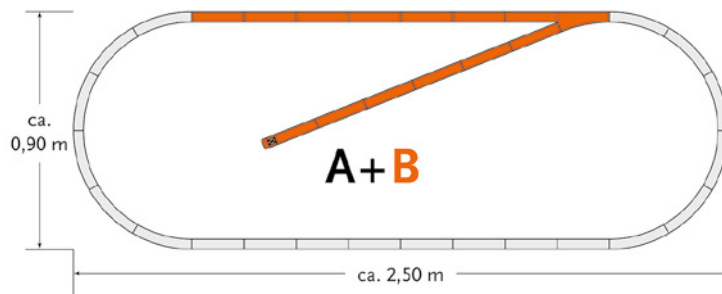

Inhalt: 13x Gerade G200 (61110), 1x Handweiche links (61140), 1x Prellbock (42608), 1x Bettungsendstück (61180); Platzbedarf ca. 250 x 90 cm

Contents: 13 straight tracks G200 (61110), 1 manual turnout left (61140), 1 buffer stop (42608), 1 roadbed end piece (61180). Space required: approx. 250 x 90 cm

geoLine Gleisset C Track set C

Art. Nr.: 61102

€ 65,00

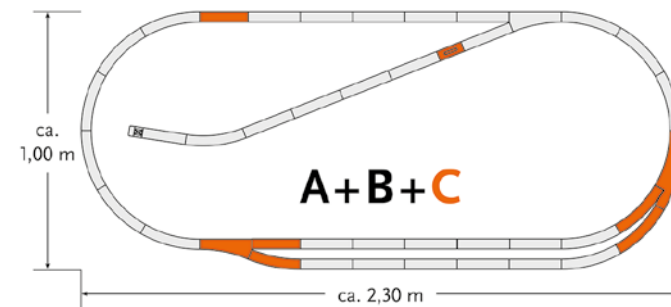

Inhalt: 2x Gerade G185 (61111), 2x Bogen R3 (61123), 1x Handentkupplungsgleis (61119), 1x Handbogenweiche rechts (61155), 1x Handweiche rechts (61141), 1x Gegenbogen (61128); Platzbedarf 230 x 100 cm

Contents: 2x straight tracks G185 (61111), 2x curves R3 (61123), 1x manual uncoupler track (61119), 1x manual curved turnout, right (61155), 1x manual turnout, right (61141), 1 complementary curve (61128). Space required: approx. 230 x 100 cm

geoLine Gleisset D Track set D

Art. Nr.: 61103

€ 114,00

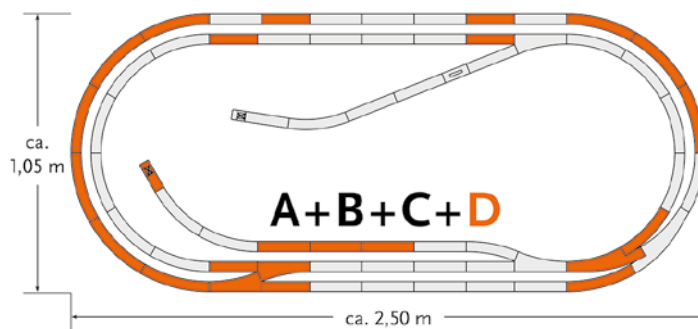

Inhalt: 3x Gerade G200 (61110), 6x Gerade G185 (61111) 1x Gerade G100 (61113), 1x Bogen R3 (61123), 10x Bogen R4 (61124), 2x Handweichen links (61140), 1x Handbogenweiche links (61154), 1x Prellbock (42608), 1x Bettungsendstück (61180); Platzbedarf ca. 243 x 106 cm

Contents: 3x straight tracks G200 (61110), 6x straight tracks G185 (61111) 1x straight tracks G100 (61113), 1x curve R3 (61123), 10x curves R4 (61124), 2x manual turnout, left (61140), 1x manual curved turnout, left (61154), 1x buffer stop (42608), 1x roadbed end piece (61180); Space required: approx. 243 x 106 cm

geoLine Gleisset E Track set E

Art. Nr.: 61104

€ 94,00

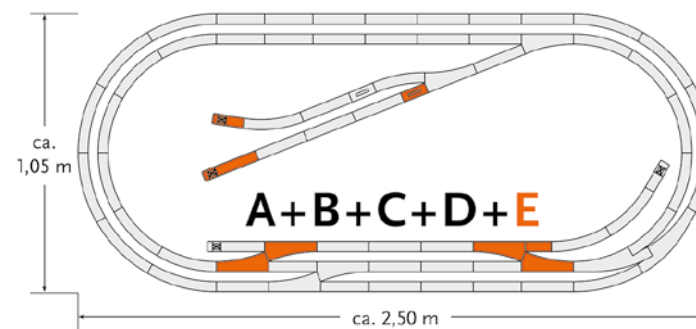

Inhalt: 1x Gerade G200 (61110), 2x Gerade G100 (61113), 2x Handweichen links (61140), 2x Handweichen rechts (61141), 2x Prellböcke (42608), 1x Handentkupplungsgleis (61119), 2x Bettungsendstücke (61180); Platzbedarf ca. 243 x 106 cm

Contents: 1x straight track G200 (61110), 2x straight tracks G100 (61113), 2x manual turnout, left (61140), 2x manual turnout, right (61141), 2x buffer stops (42608), 1x manual uncoupler track (61119), 2x roadbed end pieces (61180); Space required: approx. 243 x 106 cm

Gleiserweiterung ... Trackextension

Vorschlag Basisgleisplan
Suggestion of a
basic layout

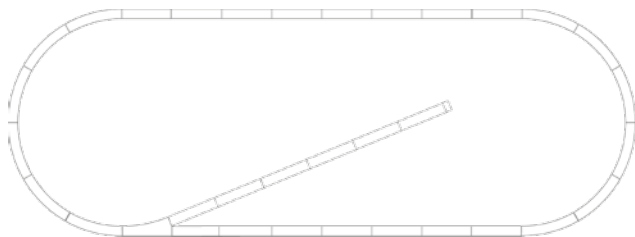

... mit den geoLine Gleis-Ergänzungssets für digitale Starter Sets / ... with the geoLine track extension sets for digital starter sets

Die perfekte Erweiterung!
The perfect complement!

Preisvorteil
Price advantage

Gleis-Ergänzungssets für Digital Starter Sets zur digitalen Steuerung von Weichen / Entkupplungsgleisen

Track extension sets for digital starter sets for digital operation of turnouts / uncoupler tracks

Art. Nr.: 51250

€ 199,00

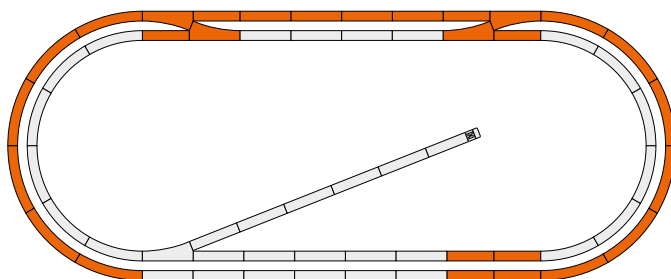

Ergänzungsset 1: Erstellen eines Parallelkreises

Inhalt:

4 Gerade G200 (61110), 8 Gerade G185 (61111), 12 Bogen R4 (61124),
2 Weichen links (61140) / 2 Weichen rechts (61141), jeweils mit elektrischen Antrieben und Weichendecodern.
5x el. Weichenantriebe und 5x Weichendecoder zum Nachrüsten für digitale Starter Sets.
Anlagengröße ca. 263 x 106 cm

Set 1: to create a parallel circle

Contents:

4 straight tracks G200 (61110), 8 straight tracks G185 (61111), 12 curves R4 (61124),
2 turnouts left (61140) / 2 turnouts right (61141), each with el. turnout motor and decoder.
5x el. turnout motors and 5x turnout decoder to upgrade digital starter sets.
Size of layout approx. 263 x 106 cm

Art. Nr.: 51251

€ 199,00

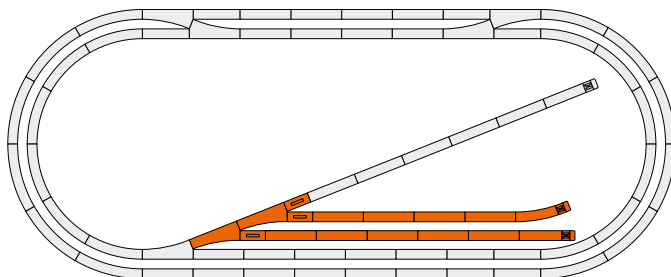

Ergänzungsset 2: Ergänzung zu 51250 zur Erstellung einer Abstellgruppe

10 Gerade G200 (61110), 1 Gegenbogen (61128),
2 Weichen rechts (61141) mit el. Antrieben und Weichendecodern.
3x elektrische Entkupplungsgleis (61118) mit eingebauten Decodern.
3x Prellbock (42608), 3 Bettungsendstücke (61180).
Anlagengröße ca. 263 x 106 cm

Set 2: extension to 51250 to create sidings

10 straight tracks G200 (61110), 1 complementary curve (61128),
2 turnouts right (61141), each with el. turnout motor and decoder.
3x el. uncoupler tracks (61118) with inbuilt decoder.
3x buffer stops (42608), 3 roadbed end pieces (61180).
Size of layout approx. 263 x 106 cm

Art. Nr.: 61106 € 14,90

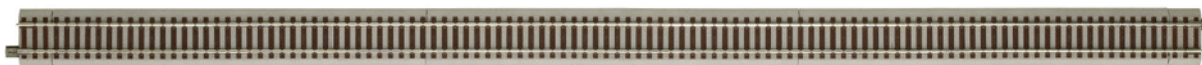

Art. Nr.: 61183 € 12,40



Set: Schwellenendstücke. Zum Ausgleich von Längendifferenzen bei Flexgleis 61106.
Inhalt 6 Endstücke, 12 Schienenverbinder, 1 Universalwerkzeug.
Set of sleeper end pieces. Used to equalise differences in length of the flex track 61106.
Content: 6 end pieces, 12 rail joiners, 1 universal tool.

Art. Nr.: 61110 € 2,60



Gerade G200, Länge 200 mm (Standardlänge)
Straight track G200, length 200 mm (standard length)

Art. Nr.: 61111 € 2,70



Gerade G185, Länge 185 mm.
Ausgleichsgerade zu den 22,5°-Weichen
Straight track G185, length 185 mm.
Adapter track for 22,5° turnouts

Art. Nr.: 61113 € 2,50



Gerade G100, Länge 100 mm (halbe Standardlänge)
Straight track G100, length 100 mm (half standard length)

Art. Nr.: 61112 € 2,60



Ausgleichsgerade G76,5, Länge 76,5 mm
Adapter straight track G76,5, length 76,5 mm

Art. Nr.: 61119 € 11,40



Hand-Entkupplungsgleis, Länge 100 mm.
(Kann nicht mit einem elektrischen Antrieb nachgerüstet werden)
Manual uncoupler track, length: 100 mm (cannot be retrofitted for electric operation)

Art. Nr.: 61118 € 27,90



Elektrisches Entkupplungsgleis, Länge 100 mm, mit elektrischem Antrieb
Electric uncoupler track, length: 100 mm, with electric motor

Art. Nr.: 61117 € 21,90



Schaltgleis, Länge 100 mm. Löst beim Befahren einen Schaltimpuls aus. Mit Prellschutz und Entstörung zur Vermeidung von Schaltspitzen. / **Switching track,** length 100 mm.
Triggers off a switching impulse when driving. Equipped with bounce protection and fault clearance to avoid switching spikes.

Art. Nr.: 61120 € 2,90



Übergangsgleis G100 zwischen geoLine Gleisen und Roco LINE-Gleisen, Länge 100 mm. / **Adapter track G100** between geoLine tracks and Roco LINE tracks, length: 100 mm

Flexgleis G800, Länge 785 mm. Zum Ausgleich von Längendifferenzen Set 61183 Schwellenendstücke verwenden.

Flexible track G800, length 785 mm. To equalise differences in length, use set of sleeper end pieces 61183.

Die geoLine Gleisgeometrie

The geoLine track geometry

61110	61110	61111
-------	-------	-------

113	113	118	119	61111
-----	-----	-----	-----	-------

		61128	61110
--	--	-------	-------

61140	61111	61110
-------	-------	-------

geoLine Gerade G185
Ausgleichsgerade zu den 22,5°-Weichen

geoLine geometry G185
Adapter track for turnouts 22,5°

61110	61111	61140
-------	-------	-------

61110	61140	61111
-------	-------	-------

Zubehör / Accessories

Art. Nr.: 61180 € 6,90



Bettungsendstück. Zur Ermöglichung eines sauberen Abschlusses bei Prellböcken, Vitrinengleisen, etc. 6 Stück/Packung.

Roadbed end piece. To finish of the roadbeds properly in the case of track bumpers, display case track etc. 6 units/pack.

Art. Nr.: 42267 € 4,40



Prellbock Bausatz.

Wahlweise mit Holzbohle oder Puffern aufzubauen. Inhalt 2 Stück.

Track bumper construction kit.

Optionally with wood plank or bumpers. 2 units/pack.

Gebogene Gleise / Curved tracks

Art. Nr.: 61122 € 2,80



Bogengleis R2, 30°, Radius = 358 mm.
Curved track R2, 30°, radius = 358 mm.

Art. Nr.: 61123 € 2,90



Bogengleis R3, 30°, Radius = 434,5 mm.
Curved track R3, 30°, radius = 434,5 mm.

Art. Nr.: 61124 € 3,40



Bogengleis R4, 30°, Radius = 511,1 mm.
Curved track R4, 30°, radius = 511,1 mm.

Art. Nr.: 61128 € 2,90

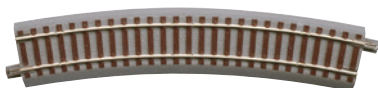

Bogengleis GB2, Radius 502,7 mm,
Gegenbogen zu 22,5°-Weichen 61140/61141.
Curved track GB2, radius 502,7 mm, comple-
mentary curve to 22,5° turnouts 61140/61141.

Art. Nr.: 61129 € 2,80



Bogengleis R2, 7,5°, Radius = 358 mm.
Curved track R2, 7,5°, radius = 358 mm.

Art. Nr.: 61130 € 2,80



Bogengleis R3, 7,5°, Radius = 434,5 mm.
Curved track R3, 7,5°, radius = 434,5 mm.

Die Gleisradien:

Der Abstand beträgt 76,5 mm, so dass auch lange Fahrzeuge bei Zugbegegnungen in der Kurve sich nicht berühren.

The track radii:

The distance is 76.5 mm so that even longer vehicles do not touch when trains enter curves

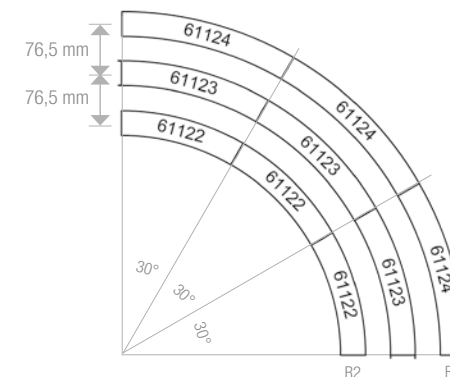

Bogenweichen Curved points

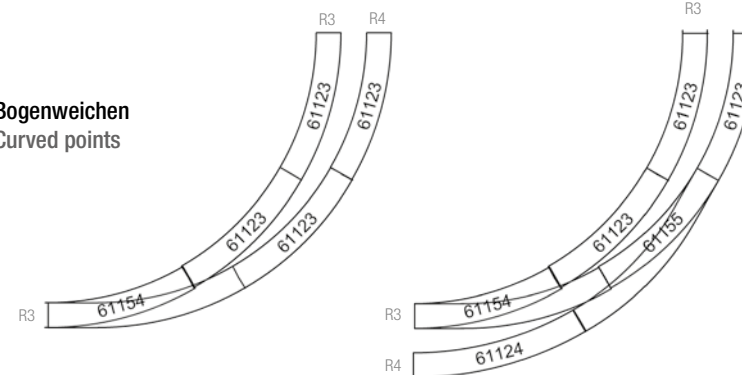

Gegenbogen 61128 für gerade Weichen, Dreiweg- und Kreuzungsweiche:

Opposite curve 61128 for straight points, threeway-point and double-slip:

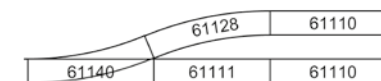

Elektr. Zubehör Electrical accessory

Art. Nr.: 61191 € 5,70

Stromeinspeisungselement für Analogbetrieb DC. Das Element kann an jeder Geraden oder jedem Bogen an den dafür vorgesehenen Stellen eingesetzt werden. **Nicht für Digitalbetrieb geeignet.**

Feed-in power element for analogue DC operation. It can be connected to any straight or curved track at a point defined in the factory. **Not suitable for digital operation.**



Art. Nr.: 61190 € 5,70

Stromeinspeisungselement für Digitalbetrieb DCC. Das Element kann an jeder Geraden oder jedem Bogen an den dafür vorgesehenen Stellen eingesetzt werden.

Feed-in power element for digital DCC operation. It can be connected to any straight or curved track at a point defined in the factory.

Weichen / Points

Art. Nr.: 61140 € 21,40

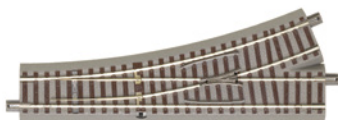

Handweiche links, Länge 200 mm (= Länge Standardgerade),
Abzweigwinkel 22,5°, Abzweigradius 502,7 mm

Turnout left, length 200 mm (= length of standard track),
branch angle 22,5°, branch radius 502,7 mm

Art. Nr.: 61141 € 21,40

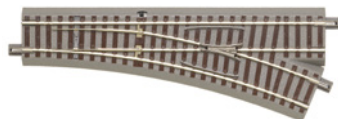

Handweiche rechts, Länge 200 mm (= Länge Standardgerade),
Abzweigwinkel 22,5°, Abzweigradius 502,7 mm

Turnout right, length: 200 mm (= Length of standard track),
branch angle 22,5°, branch radius 502,7 mm

Art. Nr.: 61154 € 33,40

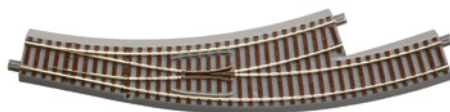

Bogenweiche links R 3/4, 30°, Radius des Stamm-
gleises und des Abzweiggleises 434,5 mm.

Curved turnout left R 3/4, 30°, radius of the main
track and the branch line 434,5 mm.

Art. Nr.: 61155 € 33,40

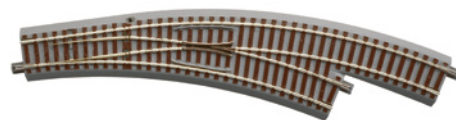

Bogenweiche rechts R 3/4, 30°, Radius des
Stammgleises und des Abzweiggleises 434,5 mm.

Curved turnout right R 3/4, 30°, radius of the main
track and the branch line 434,5 mm.

Art. Nr.: 61160 € 46,90

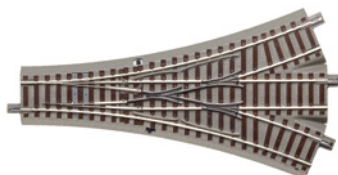

Dreiwegweiche, Länge 200 mm (= Länge Standardgerade),
Abzweigwinkel je 22,5°, symmetrisch

Three-way turnout, length 200 mm (= length of standard track),
branch angle 22,5° each, symmetrical

Art. Nr.: 61164 € 51,90

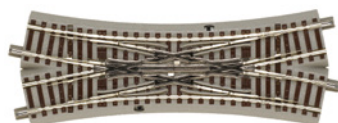

Doppelkreuzungsweiche, 22,5°, Länge 200 mm (= Länge
Standardgerade)

Double slip, 22,5°, left hand crossing, length 200 mm (= length
of standard track)

Elektr. Zubehör / Electrical accessory

Art. Nr.: 61195 € 21,90



Universalweichenantrieb elektrisch, zum nachträglichen Umrüsten von
allen geoLine Weichen von Handbetrieb auf elektrischen Betrieb.

General purpose turnout mechanism, to convert each geoLine turnout
from manual operation to electrical operation.

Gleisgeometrie mit WinTrack Planungs-Software erstellt /
Track geometry illustrations: WinTrack planning software

Normalweichen:
Standard points:

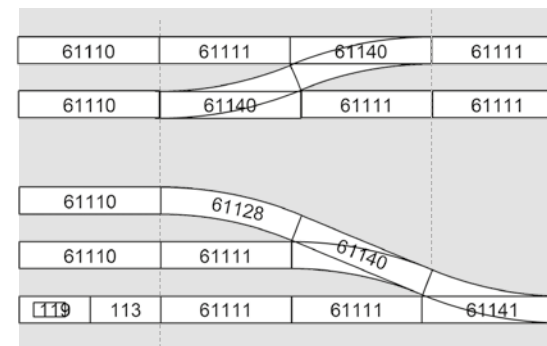

Dreiweg-Weichen
Kreuzungsweichen:
Threeway points
Double slip:

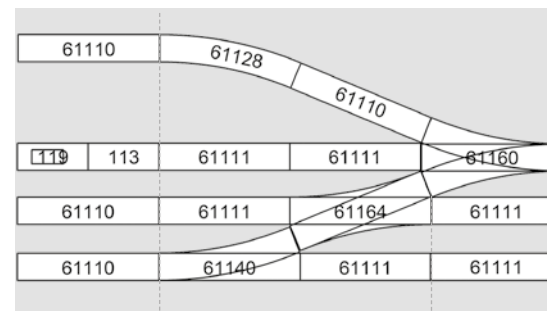

Zubehör / Accessories

Art. Nr.: 61192 € 4,30



**Isolierschienenverbinder mit Universalwerk-
zeug**. Packungsinhalt: 28 Stück Isolierschienen-
verbinder.

Insulated rail connector with universal tool. 28
units/pack.



Impressum Imprint

Herausgeber / Published by:

Modelleisenbahn München GmbH, Kronstadter Str. 4, 81667 München, Deutschland
www.roco.cc

Preise / Price indication:

Bei den im Prospekt angegebenen Preisen handelt es sich um die zum Zeitpunkt der Drucklegung gültige unverbindliche Preisempfehlung des Herstellers. Wir behalten uns ausdrücklich jederzeitige Preis Anpassungen vor. Roco Produkte und Ersatzteile werden über den Modellbahnfachhandel sowie im eigenen e-Shop vertrieben.

The prices specified in this folder are the manufacturer's suggested retail prices at the time the folder went to press. We explicitly reserve the right to make price adjustments at any time. Roco products and spare parts are available through specialized dealers and online at www.roco.cc.

Bildnachweise / photo credits:

Modelleisenbahn München GmbH, M. Zirn, S. Zenzmaier, bluforce group, Siemens, Fotolia, Fleischmann-Archiv, Georg Dahlhoff Fotografie sowie bei den Bildern angegebene Fotografen.

Druck und Verarbeitung / printing and processing:

NP Druck – Druck- und Verlagsgesellschaft m.b.H., Gutenbergstraße 12, 3100 St. Pölten

Haftung / Liability:

Dieser Prospekt ist mit hoher Qualität und Sorgfalt erstellt. Es wird aber keine Haftung für die Richtigkeit sowie Vollständigkeit der Inhalte übernommen. Für eventuelle Schäden materieller oder ideeller Art durch Nutzung, Nichtnutzung oder Vorenthaltung von fehlerhaften oder unvollständigen Informationen in diesem Prospekt – soweit sie nicht durch nachweislichen Vorsatz oder nachweisliche grobe Fahrlässigkeit seitens der Modelleisenbahn München GmbH begründet sind – kann keinerlei Gewähr und Haftung übernommen werden. Wir behalten es uns vor, jederzeit die Inhalte des Prospektes sowie die technischen Eigenschaften der darin enthaltenen Produkte zu aktualisieren. Die Wiedergabe von Warenbezeichnungen, Marken, Handelsnamen oder Firmenbezeichnungen und sonstigen Kennzeichen in diesem Neuheitenprospekt berechtigt nicht zu der Annahme, dass diese von jedermann frei benutzt werden dürfen. Vielmehr kann es sich auch dann um eingetragene Marken oder sonstige gesetzlich geschützte Kennzeichen handeln, wenn sie nicht als solche markiert sind. Viele Abbildungen zeigen Handmuster. Die endgültige und gelieferte Ausführung der Modelle kann deshalb von den gezeigten Bildern abweichen.

We strive to provide the content of this folder with the highest quality. Despite of our best effort and the best possible care Modelleisenbahn München GmbH is not liable and gives no warranty for the accuracy, the up-to-dateness or completeness of the contents and the information given in this folder. For eventual damages of material or ideal nature that result from the use, the non-use or the withholding of faulty or incomplete information in this folder - as far as it is not founded in demonstrable intent and negligence on part of the Modelleisenbahn München GmbH - no guarantee or liability can be given. We furthermore reserve the right to update the contents of the folder as well as the technical specifications of the contained products at any time. The copying of the identifications, trade brands, trade names or company names and other characteristics in this folder does not justify the assumption that those can be used by everybody free of charge. It can rather be that it is a registered trademark or characteristics otherwise protected by law even if these are not specifically marked up as such.

Symbole der Bahnverwaltungen

Symbols of railway operators

(Nicht alle kommen in diesem Folder vor) / Not all appear in this folder

	Österreichische Bundesbahnen (ÖBB) Austrian Federal Railways (ÖBB) - after World War II
	Nationale Gesellschaft der belgischen Eisenbahnen National Railway Company of Belgium (SNCB/NMBS)
	Schweizerische Bundesbahnen Swiss Federal Railways (SBB, CFE, FFS)
	Lötschbergbahn AG Private Bahngesellschaft Private Railway company
	Königl. Preußische Eisenbahn-Verwaltung (K.P.E.V.) Royal Prussian Railway Administration (K.P.E.V.)
	Königliche Bayerische Staatseisenbahn Royal Bavarian State Railways
	Deutsche Reichsbahn (Gesellschaft) (bis 1945) DRG/DRB German Reich Railway Company (up until 1945), DRG, DRB
	Deutsche Reichsbahn (nach 1945) DR German Reich Railway (starting 1945), DR
	Deutsche Reichsbahn (ab etwa 1968) German Reich Railway (approx. since 1968)
	Deutsche Bundesbahn (1951-1993)
	Deutsche Bahn AG (seit 1.1.1994)
	Dänische Staatsbahnen Danish State Railways
	Spanische Staatsbahn Spanish Railways
	Nationale Gesellschaft der französischen Eisenbahnen National French Railways (SNCF)
	Ungarische Staatsbahn Hungarian Railways (MÁV)
	Raab-Ödenburg-Ebenfurter-Eisenbahn/Gysev Raab-Ödenburg-Ebenfurter-Eisenbahn/Gysev
	Italienische Staatsbahn Italian State Railways
	Norwegische Staatsbahn Norwegian State Railways
	Niederländische Staatsbahn Dutch Railways
	Polnische Staatsbahn Polish State Railways
	Schwedische Staatsbahn Swedish State Railways
	Privates Eisenbahnverkehrsunternehmen Private Railway Companies

	Österreich Austria (A)		Deutschland Germany (D)		Frankreich France (F)		Norwegen Norway (N)		Schweden Sweden (S)
	Belgien Belgium (B)		Dänemark Denmark (DK)		Ungarn Hungary (H)		Niederlande Netherlands (NL)		Polen Poland (PL)
	Schweiz Switzerland (CH)		Spanien Spain (E)		Italien Italy (I)				

Zeichenerklärung / Legend

Art. Nr.: 00000	Artikelnummer / Article number		Gleichstrom mit Sound / Direct current DC w. sound
	Bahnverwaltung / Railway administration		Wechselstrom / Alternating current AC
Ep	Epoche / Epoch		Wechselstrom m. Sound / AC w. Sound
	Länge über Puffer / Overall length	DCC	DCC (Digital ab Werk mit Decoder) / DCC (digital)
	Gleichstrom / Direct current DC		Schnittstelle 8 polig / 8 pole interface: NEM 652

We strive to provide the content of this folder with the highest quality. Despite of our best effort and the best possible care Modelleisenbahn München GmbH is not liable and gives no warranty for the accuracy, the up-to-dateness or completeness of the contents and the information given in this folder. For eventual damages of material or ideal nature that result from the use, the non-use or the withholding of faulty or incomplete information in this folder - as far as it is not founded in demonstrable intent and negligence on part of the Modelleisenbahn München GmbH - no guarantee or liability can be given. We furthermore reserve the right to update the contents of the folder as well as the technical specifications of the contained products at any time. The copying of the identifications, trade brands, trade names or company names and other characteristics in this folder does not justify the assumption that those can be used by everybody free of charge. It can rather be that it is a registered trademark or characteristics otherwise protected by law even if these are not specifically marked up as such.

Dieser Prospekt ist mit hoher Qualität und Sorgfalt erstellt. Es wird aber keine Haftung für die Richtigkeit sowie Vollständigkeit der Inhalte übernommen. Für eventuelle Schäden materieller oder ideeller Art durch Nutzung, Nichtnutzung oder Vorenthaltung von fehlerhaften oder unvollständigen Informationen in diesem Prospekt – soweit sie nicht durch nachweislichen Vorsatz oder nachweisliche grobe Fahrlässigkeit seitens der Modelleisenbahn München GmbH begründet sind – kann keinerlei Gewähr und Haftung übernommen werden. Wir behalten es uns vor, jederzeit die Inhalte des Prospektes sowie die technischen Eigenschaften der darin enthaltenen Produkte zu aktualisieren. Die Wiedergabe von Warenbezeichnungen, Marken, Handelsnamen oder Firmenbezeichnungen und sonstigen Kennzeichen in diesem Neuheitenprospekt berechtigt nicht zu der Annahme, dass diese von jedermann frei benutzt werden dürfen. Vielmehr kann es sich auch dann um eingetragene Marken oder sonstige gesetzlich geschützte Kennzeichen handeln, wenn sie nicht als solche markiert sind. Viele Abbildungen zeigen Handmuster. Die endgültige und gelieferte Ausführung der Modelle kann deshalb von den gezeigten Bildern abweichen.

Haftung / Liability:

3100 St. Pölten

NP Druck – Druck- und Verlagsgesellschaft m.b.H., Gutenbergstraße 12,

Druck und Verarbeitung / printing and processing:

Bildern angegebene Fotografen.

Modelleisenbahn München GmbH, M. Zirn, S. Zenzmaier, bluforce group, Siemens, Fotolia, Fleischmann-Archiv, Georg Dahlhoff Fotografie sowie bei den

Bildnachweise / photo credits:

The prices specified in this folder are the manufacturer's suggested retail prices at the time the folder went to press. We explicitly reserve the right to make price adjustments at any time. Roco products and spare parts are available through specialized dealers and online at www.fleischmann.de

fachhandel sowie im eigenen e-Shop vertrieben.
Hersteller. Wir behalten uns ausdrücklich jederzeitige Preis Anpassungen
Zeitpunkt der Drucklegung gültige unverbindliche Preisempfehlung des
Bei den im Prospekt angegebenen Preisen handelt es sich um die zum

Preis / Price indication:

www.fleischmann.de

81667 München, Deutschland

Modelleisenbahn München GmbH, Kronstadter Str. 4,

Herausgeber :

